

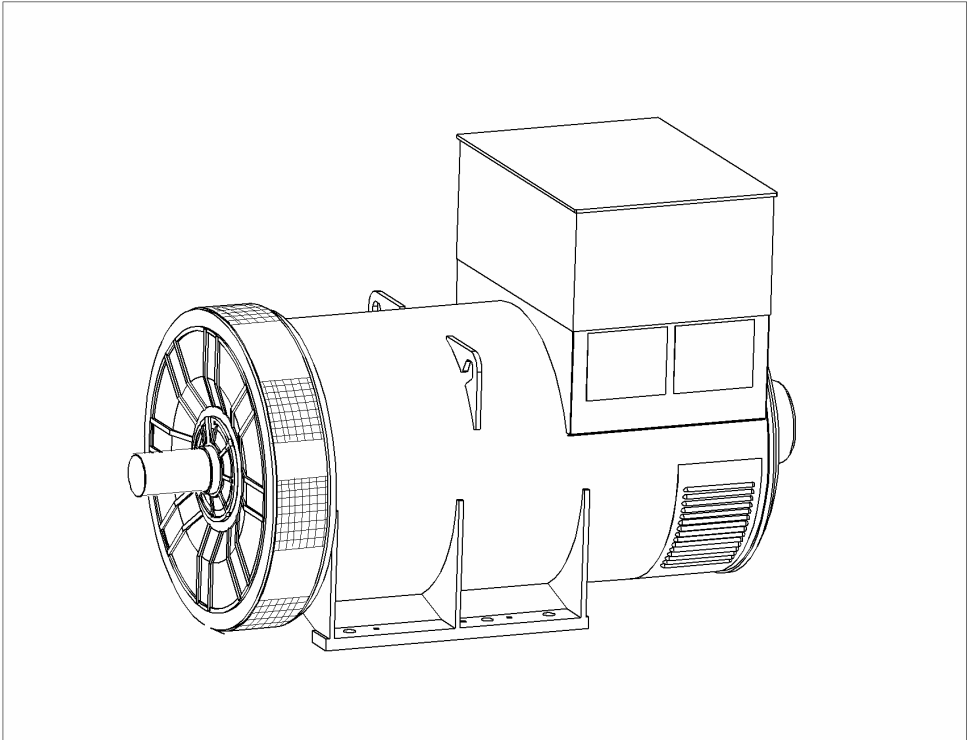

PM734D - Technical Data Sheet



PM734D

SPECIFICATIONS & OPTIONS



STANDARDS

Marine generators may be certified to Lloyds, DnV, Bureau Veritas, ABS, Germanischer-Lloyd or RINA. Other standards and certifications can be considered on request.

DESCRIPTION

The STAMFORD PM range of synchronous ac generators are brushless with a rotating field. They are separately excited by the STAMFORD Permanent Magnet Generator (PMG). This is a shaft mounted, high frequency, pilot exciter which provides a constant supply of clean power via the Automatic Voltage Regulator (AVR) to the main exciter. The main exciter output is fed to the main rotor, through a full wave bridge rectifier, protected by surge suppression.

VOLTAGE REGULATORS

The PM range generators, complete with PMG, are available with one of two AVRs. Each AVR has soft start voltage build up and built in protection against sustained over-excitation, which will de-excite the generator after a minimum of 8 seconds.

Underspeed protection (UFRO) is also provided on both AVRs. The UFRO will reduce the generator output voltage proportional to the speed of the generator below a pre-settable level.

The **MX341 AVR** is two phase sensed with a voltage regulation of $\pm 1\%$. (see the note on regulation).

The **MX321 AVR** is 3 phase rms sensed with a voltage regulation of 0.5% rms (see the note on regulation). The UFRO circuit has adjustable slope and dwell for controlled recovery from step loads. An over voltage protection circuit will shutdown the output device of the AVR, it can also trip an optional excitation circuit breaker if required. As an option, short circuit current limiting is available with the addition of current transformers.

Newage may use a third AVR, the MA330, under certain circumstances.

The **MA330 AVR** has 3 phase rms sensing, it has similar performance to the MX321. It is a Pulse Width Modulated AVR with a higher output power under short circuit conditions.

All of the above AVRs require a generator mounted current transformer to provide quadrature droop characteristics for load sharing during parallel operation. Provision is also made for the connection of the STAMFORD power factor controller, for embedded applications, and a remote voltage trimmer.

WINDINGS & ELECTRICAL PERFORMANCE

All generator stators are wound to 2/3 pitch. This eliminates triplen (3rd, 9th, 15th ...) harmonics on the voltage waveform and is found to be the optimum design for trouble-free supply of non-linear loads. The 2/3 pitch design avoids excessive neutral currents sometimes seen with higher winding pitches. A fully connected damper winding reduces oscillations during paralleling. This winding, with the 2/3 pitch and carefully selected pole and tooth designs, ensures very low levels of voltage waveform distortion.

TERMINALS & TERMINAL BOX

Standard generators feature a main stator with 6 ends brought out to the terminals, which are mounted on the frame at the non-drive end of the generator. A sheet steel terminal box contains the AVR and provides ample space for the customers' wiring and gland arrangements. It has removable panels for easy access.

SHAFT & KEYS

All generator rotors are dynamically balanced to better than BS6861:Part 1 Grade 2.5 for minimum vibration in operation. Two bearing generators are balanced with a half key.

INSULATION/IMPREGNATION

The insulation system is class 'H', and meets the requirements of UL1446.

All wound components are impregnated with materials and processes designed specifically to provide the high build required for static windings and the high mechanical strength required for rotating components.

QUALITY ASSURANCE

Generators are manufactured using production procedures having a quality assurance level to BS EN ISO 9001.

NOTE ON REGULATION

The stated voltage regulation may not be maintained in the presence of certain radio transmitted signals.

Any change in performance will fall within the limits of Criteria 'B' of EN 61000-6-2:2001. At no time will the steady-state voltage regulation exceed 2%.

Note: Continuous development of our products entitles us to change specification details without notice, therefore they must not be regarded as binding.

Front cover drawing is typical of the product range.

PM734D
WINDING 312

CONTROL SYSTEM	SEPARATELY EXCITED BY P.M.G.			
A.V.R.	MX341	MX321	MA330	
VOLTAGE REGULATION	± 1%	± 0.5 %	± 0.5 %	With 4% ENGINE GOVERNING
SUSTAINED SHORT CIRCUIT	REFER TO SHORT CIRCUIT DECREMENT CURVES (page 7)			

INSULATION SYSTEM	CLASS H
PROTECTION	IP23
RATED POWER FACTOR	0.8
STATOR WINDING	DOUBLE LAYER LAP
WINDING PITCH	TWO THIRDS
WINDING LEADS	6
MAIN STATOR RESISTANCE	0.00114 Ohms PER PHASE AT 22°C STAR CONNECTED
MAIN ROTOR RESISTANCE	1.98 Ohms at 22°C
EXCITER STATOR RESISTANCE	17.5 Ohms at 22°C
EXCITER ROTOR RESISTANCE	0.048 Ohms PER PHASE AT 22°C
R.F.I. SUPPRESSION	BS EN 61000-6-2 & BS EN 61000-6-4, VDE 0875G, VDE 0875N. refer to factory for others
WAVEFORM DISTORTION	NO LOAD < 1.5% NON-DISTORTING BALANCED LINEAR LOAD < 5.0%
MAXIMUM OVERSPEED	2250 Rev/Min
BEARING DRIVE END	BALL. 6228 C3
BEARING NON-DRIVE END	BALL. 6319 C3

	1 BEARING	2 BEARING
WEIGHT COMP. GENERATOR	3318 kg	3267 kg
WEIGHT WOUND STATOR	1619 kg	1619 kg
WEIGHT WOUND ROTOR	1383 kg	1321 kg
WR ² INERTIA	41.2206 kgm ²	40.2197 kgm ²
SHIPPING WEIGHTS in a crate	3391kg	3336kg
PACKING CRATE SIZE	216 x 105 x 154(cm)	216 x 105 x 154(cm)

	50 Hz				60 Hz			
TELEPHONE INTERFERENCE	THF<2%				TIF<50			
COOLING AIR	2.69 m ³ /sec 5700 cfm				3.45 m ³ /sec 7300 cfm			
VOLTAGE STAR	380/220	400/231	415/240	440/254	416/240	440/254	460/266	480/277
KVA BASE RATING FOR REACTANCE VALUES	1445	1490	1490	1460	1635	1745	1780	1815
X _d DIR. AXIS SYNCHRONOUS	2.79	2.60	2.41	2.10	3.37	3.22	3.00	2.81
X' _d DIR. AXIS TRANSIENT	0.17	0.16	0.15	0.13	0.21	0.20	0.18	0.17
X'' _d DIR. AXIS SUBTRANSIENT	0.13	0.12	0.11	0.09	0.15	0.15	0.14	0.13
X _q QUAD. AXIS REACTANCE	1.80	1.67	1.55	1.35	2.17	2.07	1.93	1.81
X'' _q QUAD. AXIS SUBTRANSIENT	0.25	0.24	0.22	0.19	0.30	0.29	0.27	0.25
X _L LEAKAGE REACTANCE	0.03	0.03	0.03	0.02	0.04	0.04	0.03	0.03
X ₂ NEGATIVE SEQUENCE	0.18	0.17	0.15	0.13	0.21	0.20	0.19	0.18
X ₀ ZERO SEQUENCE	0.02	0.02	0.02	0.02	0.03	0.03	0.02	0.02

REACTANCES ARE SATURATED

VALUES ARE PER UNIT AT RATING AND VOLTAGE INDICATED

T' _d TRANSIENT TIME CONST.	0.137s
T'' _d SUB-TRANSTIME CONST.	0.01s
T' _{do} O.C. FIELD TIME CONST.	2.25s
T _a ARMATURE TIME CONST.	0.02s
SHORT CIRCUIT RATIO	1/X _d

**50
Hz**

PM734D
Winding 312



THREE PHASE EFFICIENCY CURVES

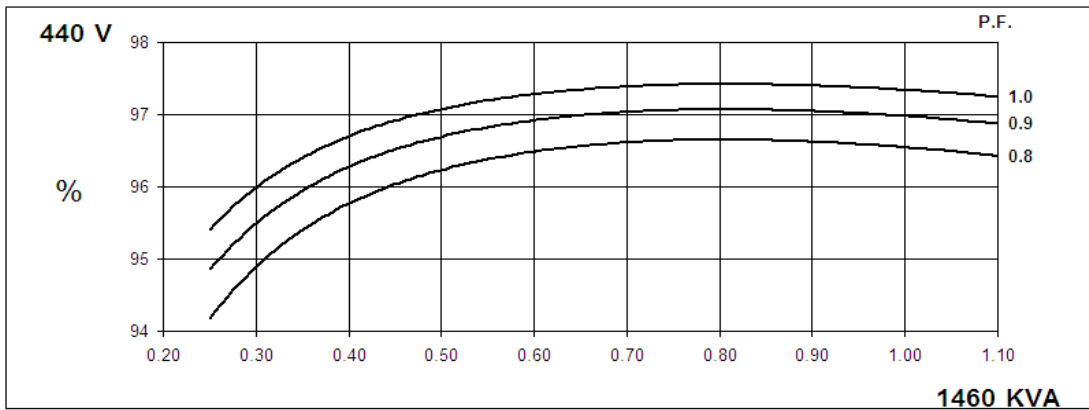
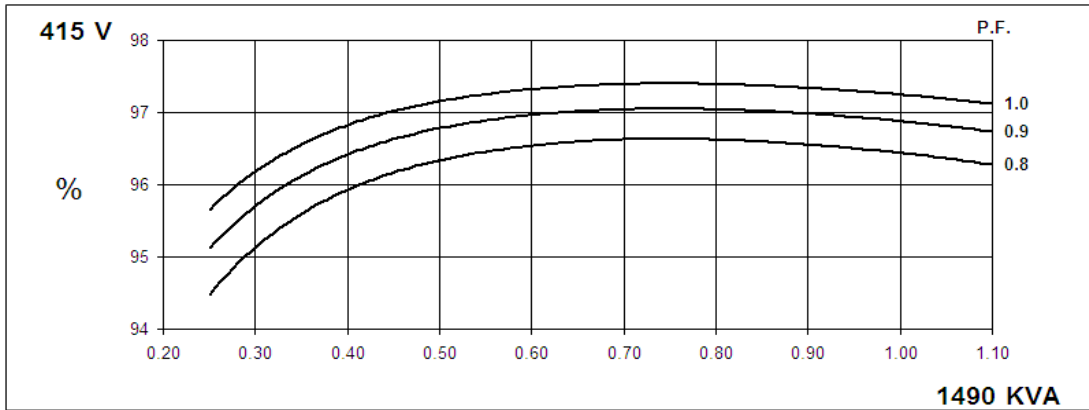
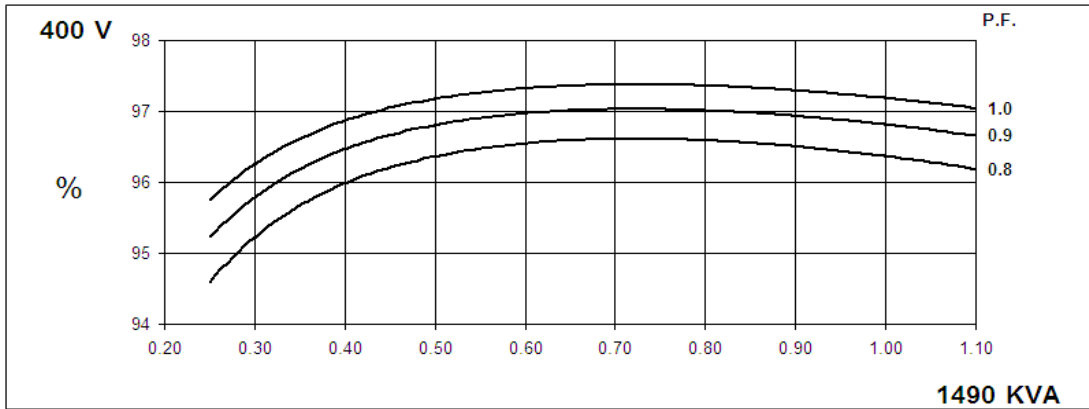
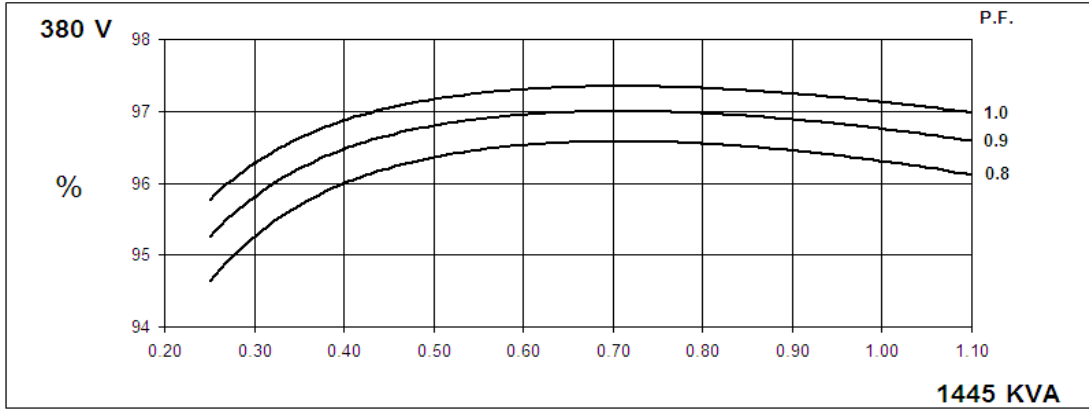

THREE PHASE EFFICIENCY CURVES

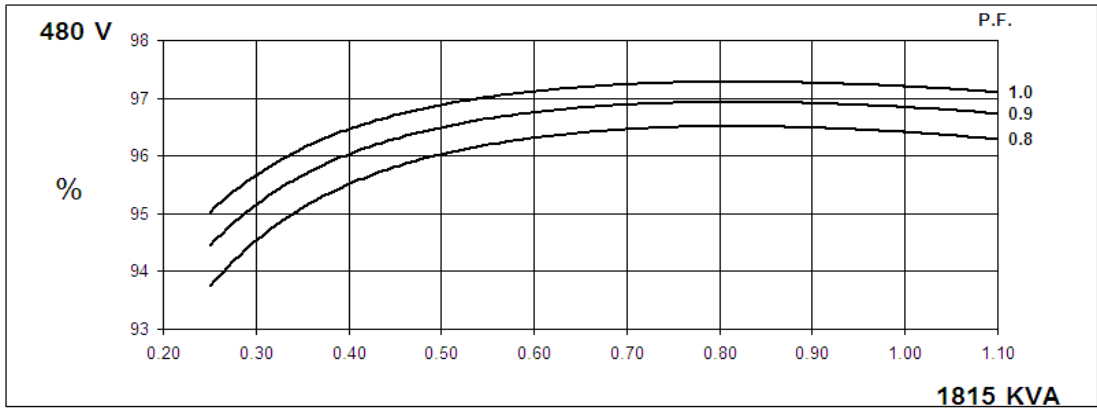
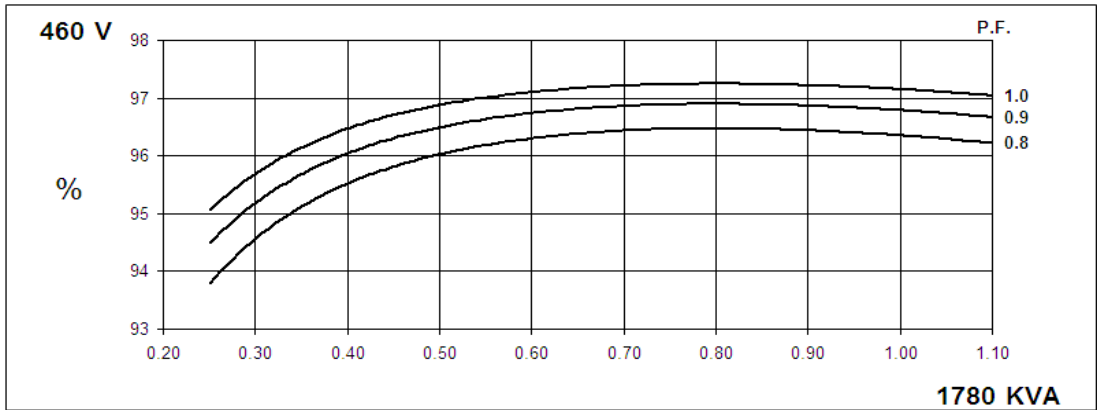
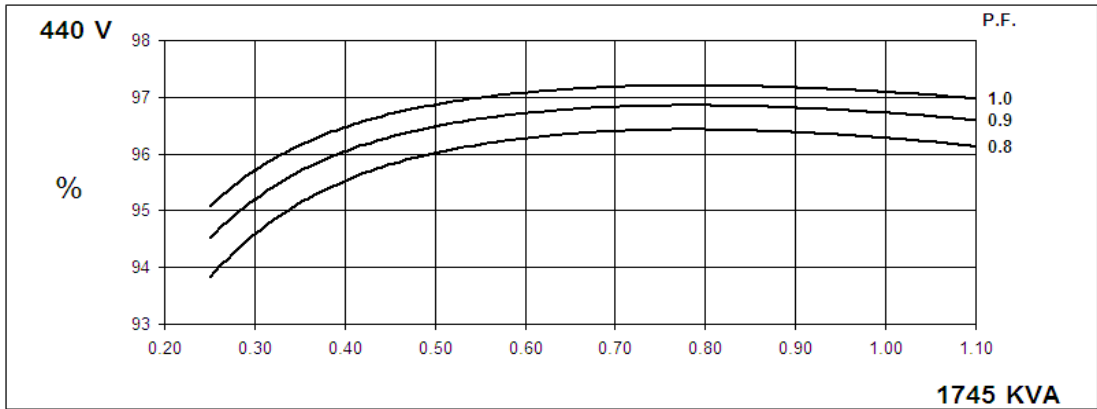
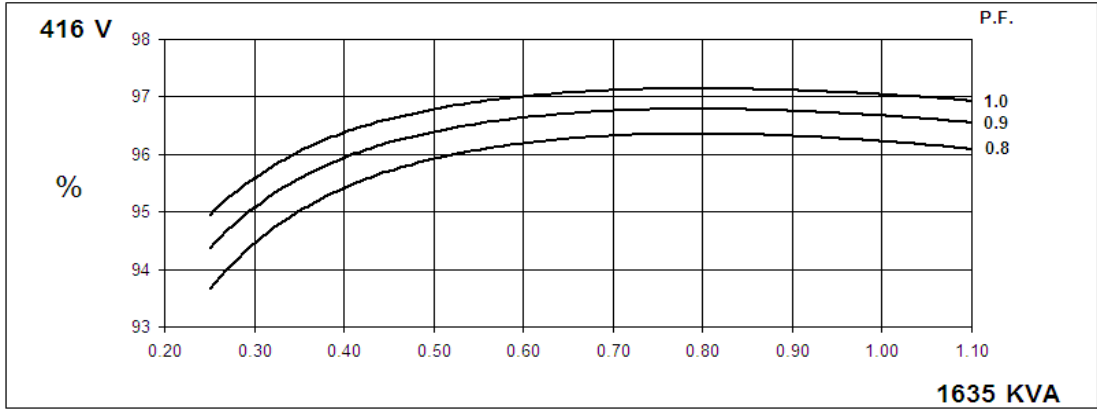

PM734D

Winding 312



Locked Rotor Motor Starting Curve

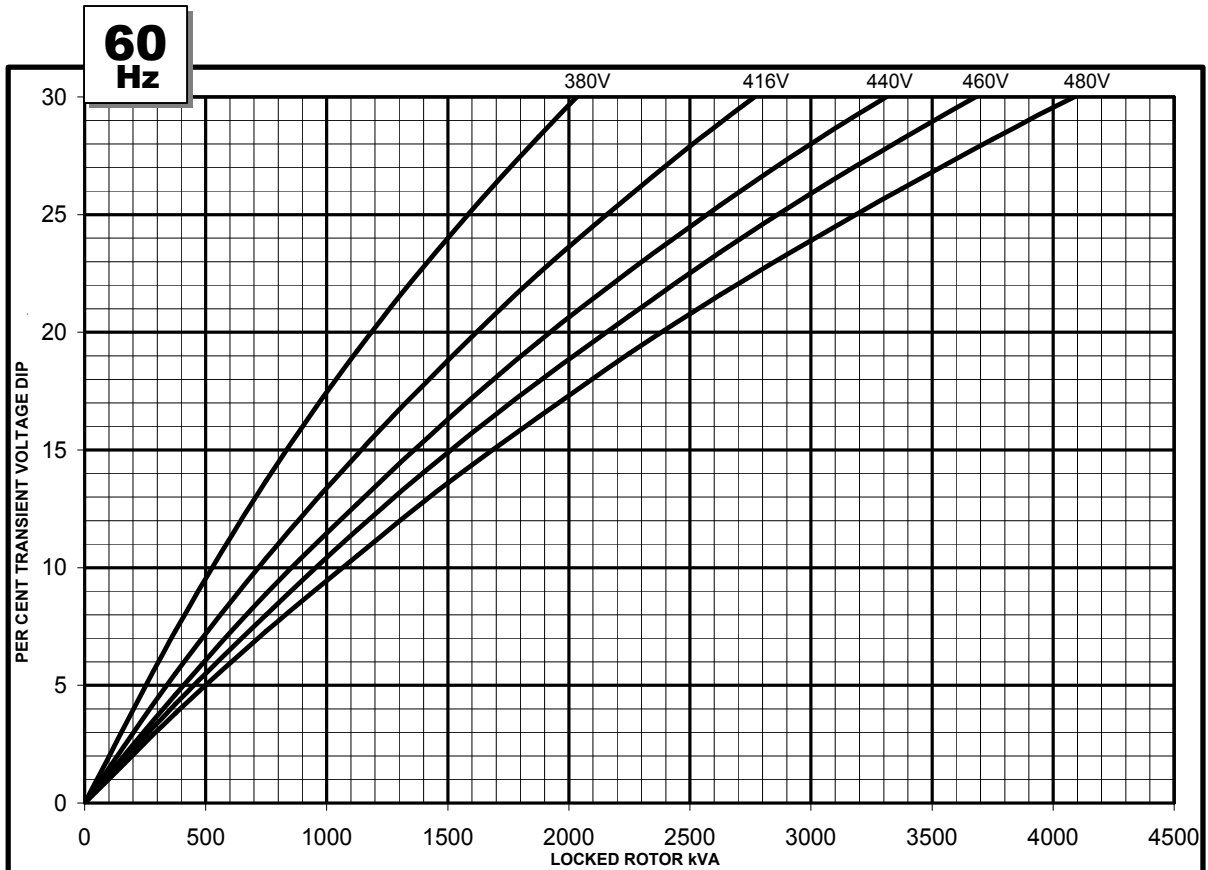
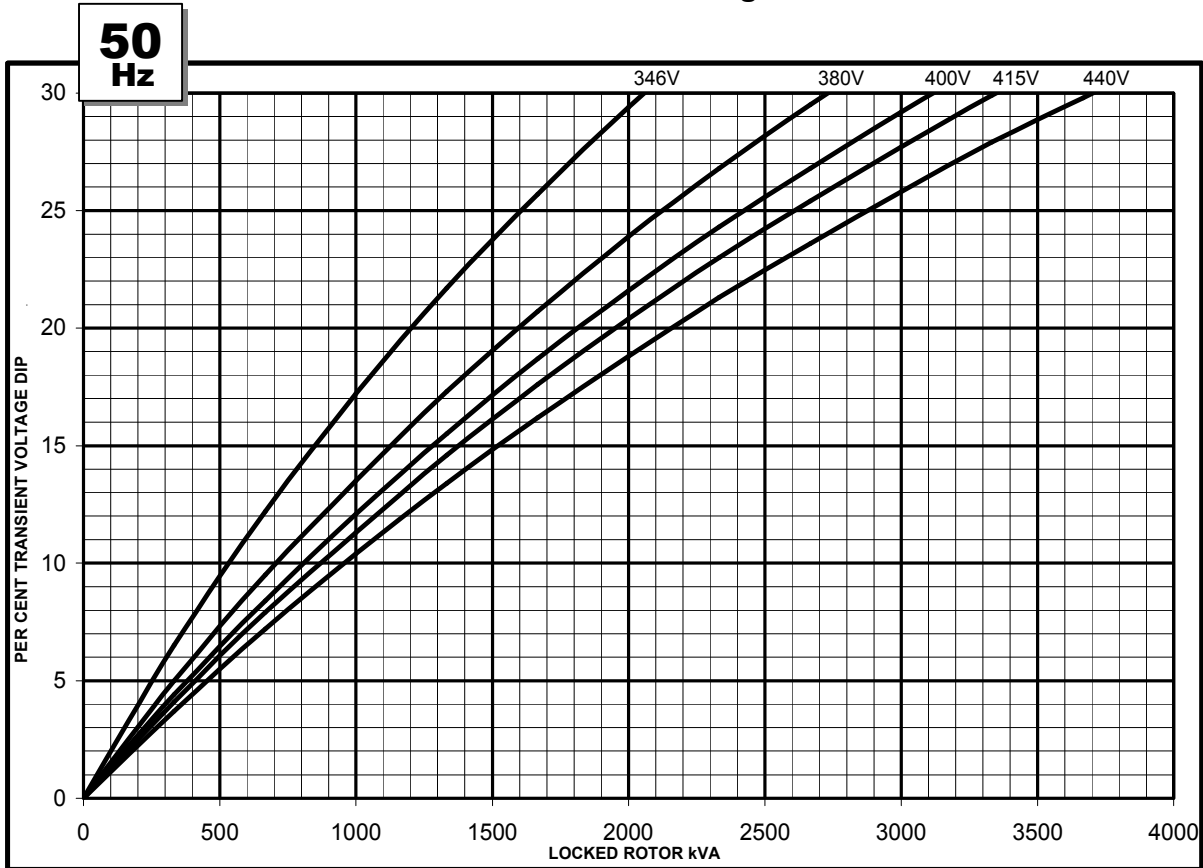

PM734D
MX341 or MX321

Three-phase Short Circuit Decrement Curve. No-load Excitation at Rated Speed
Based on star (wye) connection.

**50
Hz**

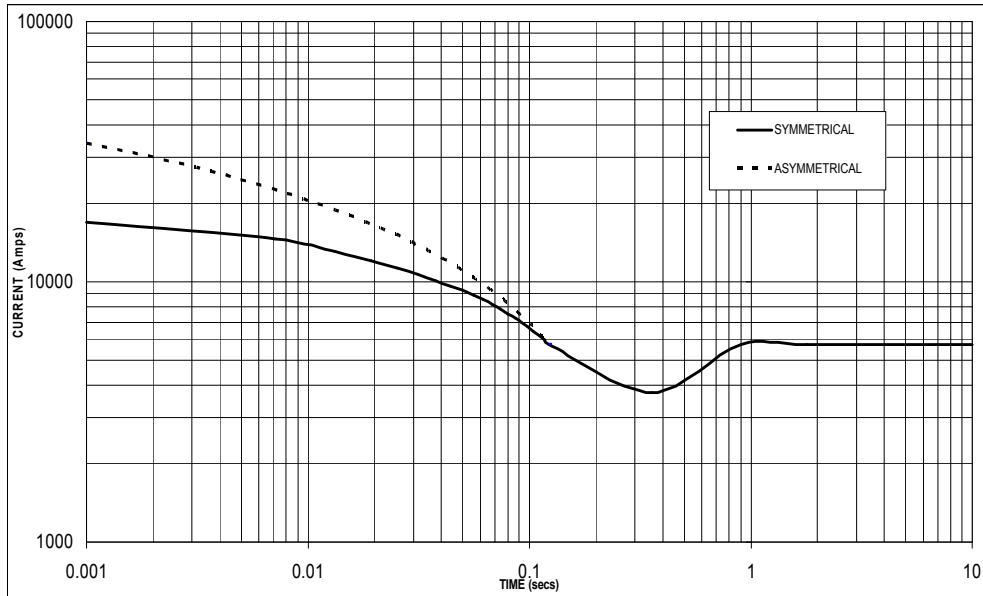

Sustained Short Circuit = 5,750 Amps

**60
Hz**

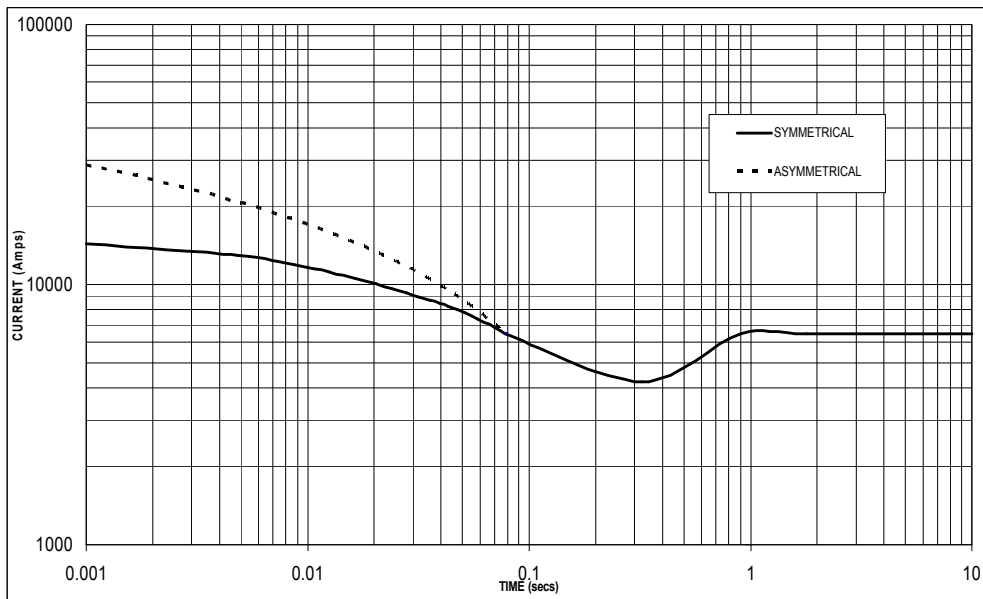

Sustained Short Circuit = 6,500 Amps

Note 1

The following multiplication factors should be used to adjust the values from curve between time 0.001 seconds and the minimum current point in respect of nominal operating voltage :

50Hz		60Hz	
Voltage	Factor	Voltage	Factor
380v	x 1.00	416v	x 1.00
400v	x 1.05	440v	x 1.06
415v	x 1.09	460v	x 1.10
440v	x 1.16	480v	x 1.15

The sustained current value is constant irrespective of voltage level

Note 2

The following multiplication factor should be used to convert the values calculated in accordance with NOTE 1 to those applicable to the various types of short circuit :

	3-phase	2-phase L-L	1-phase L-N
Instantaneous	x 1.00	x 0.87	x 1.30
Minimum	x 1.00	x 1.80	x 3.20
Sustained	x 1.00	x 1.50	x 2.50
Max. sustained duration	10 sec.	5 sec.	2 sec.

All other times are unchanged

Note 3

Curves are drawn for Star (Wye) connected machines.

**Three-phase Short Circuit Decrement Curve. No-load Excitation at Rated Speed
Based on star (wye) connection.**

**50
Hz**

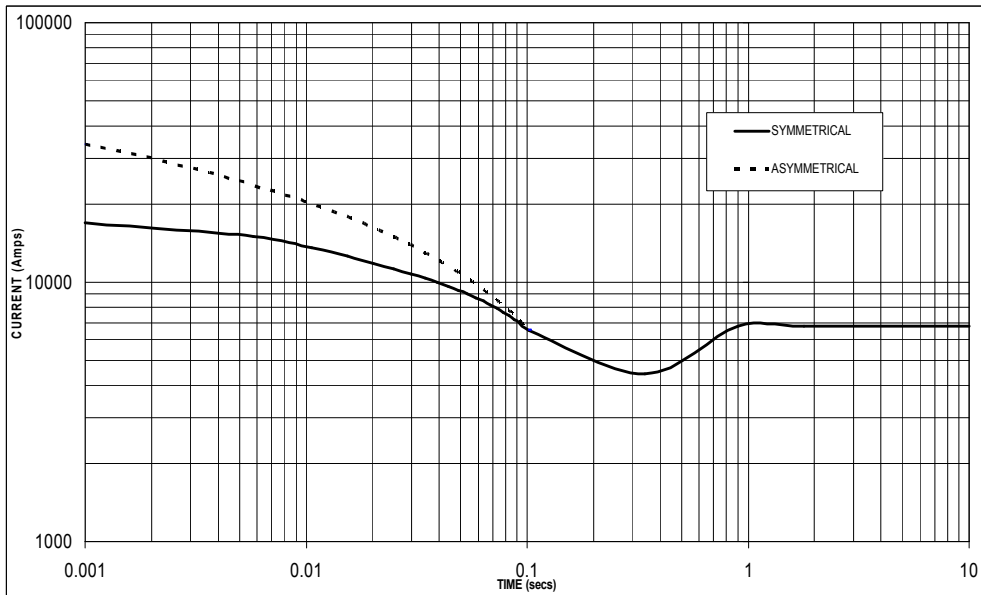

Sustained Short Circuit = 6,800 Amps

**60
Hz**

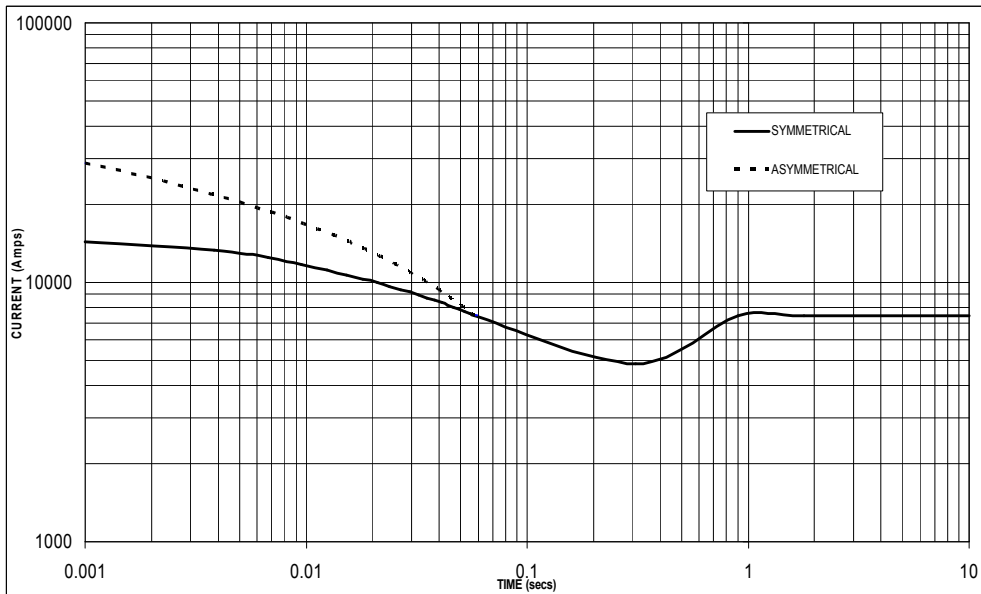

Note 1

The following multiplication factors should be used to adjust the values from curve between time 0.001 seconds and the minimum current point in respect of nominal operating voltage :

50Hz		60Hz	
Voltage	Factor	Voltage	Factor
380v	x 1.00	416v	x 1.00
400v	x 1.05	440v	x 1.06
415v	x 1.09	460v	x 1.10
440v	x 1.16	480v	x 1.15

The sustained current value is constant irrespective of voltage level

Note 2

The following multiplication factor should be used to convert the values calculated in accordance with NOTE 1 to those applicable to the various types of short circuit :

	3-phase	2-phase L-L	1-phase L-N
Instantaneous	x 1.00	x 0.87	x 1.30
Minimum	x 1.00	x 1.80	x 3.20
Sustained	x 1.00	x 1.50	x 2.50
Max. sustained duration	10 sec.	5 sec.	2 sec.

All other times are unchanged

Note 3

Curves are drawn for Star (Wye) connected machines.

PM734D

Winding 312 / 0.8 Power Factor



RATINGS

Class - Temp Rise		Cont. B - 70/50°C				Cont. F - 90/50°C				Cont. H - 110/50°C			
50Hz	Star (V)	380	400	415	440	380	400	415	440	380	400	415	440
	kVA	1150	1190	1190	1165	1255	1320	1345	1320	1445	1490	1490	1460
	kW	920	952	952	932	1004	1056	1076	1056	1156	1192	1192	1168
	Efficiency (%)	96.5	96.6	96.6	96.7	96.5	96.5	96.6	96.6	96.3	96.4	96.4	96.5
	kW Input	953	986	986	964	1040	1094	1114	1093	1200	1237	1237	1210

60Hz	Star (V)	416	440	460	480	416	440	460	480	416	440	460	480
	kVA	1305	1390	1420	1450	1480	1580	1610	1645	1635	1745	1780	1815
	kW	1044	1112	1136	1160	1184	1264	1288	1316	1308	1396	1424	1452
	Efficiency (%)	96.4	96.4	96.5	96.5	96.3	96.4	96.4	96.5	96.2	96.3	96.4	96.4
	kW Input	1083	1154	1177	1202	1229	1311	1336	1364	1360	1450	1477	1506

DIMENSIONS

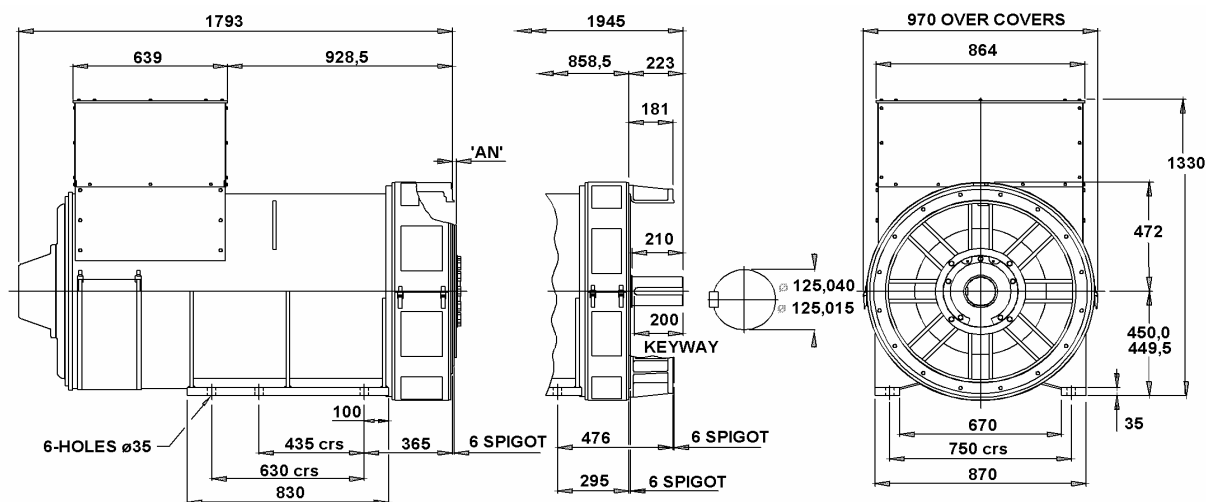

COUPLING DISC	'AN'
S.A.E No 18	15,7
S.A.E No 21	0
S.A.E No 24	0

1-BRG ADAPTORS
S.A.E No 0
S.A.E No 00

2-BRG ADAPTORS
S.A.E No 0
S.A.E No 00



Barnack Road • Stamford • Lincolnshire • PE9 2NB
 Tel: 00 44 (0)1780 484000 • Fax: 00 44 (0)1780 484100
 Website: www.newage-avkseg.com