

PM736D - Technical Data Sheet

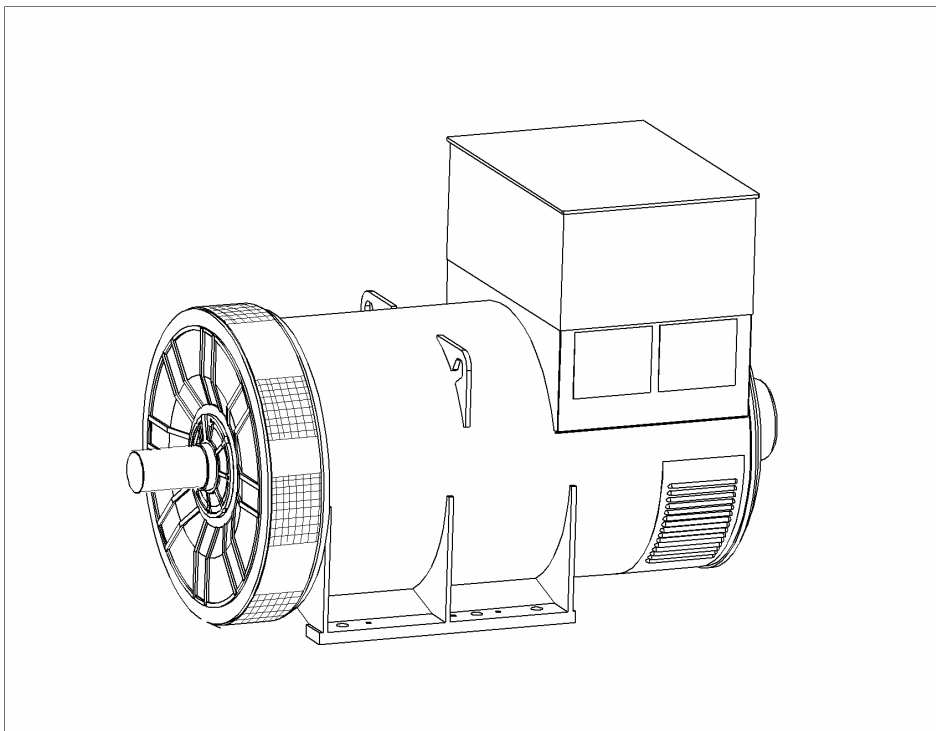

PM736D

SPECIFICATIONS & OPTIONS



STANDARDS

Marine generators may be certified to Lloyds, DnV, Bureau Veritas, ABS, Germanischer-Lloyd or RINA. Other standards and certifications can be considered on request.

DESCRIPTION

The STAMFORD PM range of synchronous ac generators are brushless with a rotating field. They are separately excited by the STAMFORD Permanent Magnet Generator (PMG). This is a shaft mounted, high frequency, pilot exciter which provides a constant supply of clean power via the Automatic Voltage Regulator (AVR) to the main exciter. The main exciter output is fed to the main rotor, through a full wave bridge rectifier, protected by surge suppression.

VOLTAGE REGULATORS

The PM range generators, complete with PMG, are available with one of two AVRs. Each AVR has soft start voltage build up and built in protection against sustained over-excitation, which will de-excite the generator after a minimum of 8 seconds. Underspeed protection (UFRO) is also provided on both AVRs. The UFRO will reduce the generator output voltage proportional to the speed of the generator below a pre-settable level.

The **MX341 AVR** is two phase sensed with a voltage regulation of $\pm 1\%$. (see the note on regulation).

The **MX321 AVR** is 3 phase rms sensed with a voltage regulation of 0.5% rms (see the note on regulation). The UFRO circuit has adjustable slope and dwell for controlled recovery from step loads. An over voltage protection circuit will shutdown the output device of the AVR, it can also trip an optional excitation circuit breaker if required. As an option, short circuit current limiting is available with the addition of current transformers.

Both of the above AVRs require a generator mounted current transformer to provide quadrature droop characteristics for load sharing during parallel operation. Provision is also made for the connection of the STAMFORD power factor controller, for embedded applications, and a remote voltage trimmer.

WINDINGS & ELECTRICAL PERFORMANCE

All generator stators are wound to 2/3 pitch. This eliminates triplen (3rd, 9th, 15th ...) harmonics on the voltage waveform and is found to be the optimum design for trouble-free supply of non-linear loads. The 2/3 pitch design avoids excessive neutral currents sometimes seen with higher winding pitches. A fully connected damper winding reduces oscillations during paralleling. This winding, with the 2/3 pitch and carefully selected pole and tooth designs, ensures very low levels of voltage waveform distortion.

TERMINALS & TERMINAL BOX

Standard generators feature a main stator with 6 ends brought out to the terminals, which are mounted on the frame at the non-drive end of the generator. A sheet steel terminal box contains the AVR and provides ample space for the customers' wiring and gland arrangements. It has removable panels for easy access.

SHAFT & KEYS

All generator rotors are dynamically balanced to better than BS6861:Part 1 Grade 2.5 for minimum vibration in operation. Two bearing generators are balanced with a half key.

INSULATION/IMPREGNATION

The insulation system is class 'H', and meets the requirements of UL1446.

All wound components are impregnated with materials and processes designed specifically to provide the high build required for static windings and the high mechanical strength required for rotating components.

QUALITY ASSURANCE

Generators are manufactured using production procedures having a quality assurance level to BS EN ISO 9001.

NOTE ON REGULATION

The stated voltage regulation may not be maintained in the presence of certain radio transmitted signals. Any change in performance will fall within the limits of Criteria 'B' of EN 61000-6-2:2001. At no time will the steady state voltage regulation exceed 2%.

Note: Continuous development of our products entitles us to change specification details without notice, therefore they must not be regarded as binding.

Front cover drawing is typical of the product range.

PM736D
WINDING 312

CONTROL SYSTEM	SEPARATELY EXCITED BY P.M.G.		
A.V.R.	MX341	MX321	
VOLTAGE REGULATION	± 1%	± 0.5 %	With 4% ENGINE GOVERNING
SUSTAINED SHORT CIRCUIT	REFER TO SHORT CIRCUIT DECREMENT CURVES (page 7)		

INSULATION SYSTEM	CLASS H							
PROTECTION	IP23							
RATED POWER FACTOR	0.8							
STATOR WINDING	DOUBLE LAYER LAP							
WINDING PITCH	TWO THIRDS							
WINDING LEADS	6							
MAIN STATOR RESISTANCE	0.0018 Ohms PER PHASE AT 22°C STAR CONNECTED							
MAIN ROTOR RESISTANCE	2.83 Ohms at 22°C							
EXCITER STATOR RESISTANCE	17 Ohms at 22°C							
EXCITER ROTOR RESISTANCE	0.1 Ohms PER PHASE AT 22°C							
R.F.I. SUPPRESSION	BS EN 61000-6-2 & BS EN 61000-6-4,VDE 0875G, VDE 0875N. refer to factory for others							
WAVEFORM DISTORTION	NO LOAD < 1.5% NON-DISTORTING BALANCED LINEAR LOAD < 5.0%							
MAXIMUM OVERSPEED	1500 Rev/Min							
BEARING DRIVE END	BALL. 6228 C3							
BEARING NON-DRIVE END	BALL. 6319 C3							
	1 BEARING				2 BEARING			
WEIGHT COMP. GENERATOR	3233 kg				3182 kg			
WEIGHT WOUND STATOR	1368 kg				1368 kg			
WEIGHT WOUND ROTOR	1548 kg				1486 kg			
WR ² INERTIA	53.5789 kgm ²				52.578 kgm ²			
SHIPPING WEIGHTS in a crate	3350kg				3372kg			
PACKING CRATE SIZE	194 x 105 x 154(cm)				194 x 105 x 154(cm)			
	50 Hz				60 Hz			
TELEPHONE INTERFERENCE	THF<2%				TIF<50			
COOLING AIR	1.79 m ³ /sec 3793 cfm				2.3 m ³ /sec 4874 cfm			
VOLTAGE STAR	380/220	400/231	415/240	440/254	416/240	440/254	460/266	480/277
kVA BASE RATING FOR REACTANCE VALUES	655	655	655	655	920	975	975	975
X _d DIR. AXIS SYNCHRONOUS	1.50	1.35	1.25	1.12	2.19	2.07	1.89	1.74
X' _d DIR. AXIS TRANSIENT	0.11	0.10	0.09	0.08	0.16	0.15	0.14	0.13
X'' _d DIR. AXIS SUBTRANSIENT	0.08	0.07	0.07	0.06	0.11	0.11	0.10	0.09
X _q QUAD. AXIS REACTANCE	0.96	0.87	0.81	0.72	1.39	1.32	1.21	1.11
X' _q QUAD. AXIS SUBTRANSIENT	0.24	0.22	0.20	0.18	0.35	0.33	0.30	0.28
X _L LEAKAGE REACTANCE	0.03	0.03	0.02	0.02	0.04	0.04	0.03	0.03
X ₂ NEGATIVE SEQUENCE	0.14	0.13	0.12	0.10	0.20	0.19	0.17	0.16
X ₀ ZERO SEQUENCE	0.02	0.02	0.01	0.01	0.03	0.02	0.02	0.02
REACTANCES ARE SATURATED				VALUES ARE PER UNIT AT RATING AND VOLTAGE INDICATED				
T' _d TRANSIENT TIME CONST.	0.162s							
T'' _d SUB-TRANSTIME CONST.	0.015s							
T' _{do} O.C. FIELD TIME CONST.	2.17s							
T _a ARMATURE TIME CONST.	0.0183s							
SHORT CIRCUIT RATIO	3				1/X _d			

**50
Hz**

PM736D
Winding 312



THREE PHASE EFFICIENCY CURVES

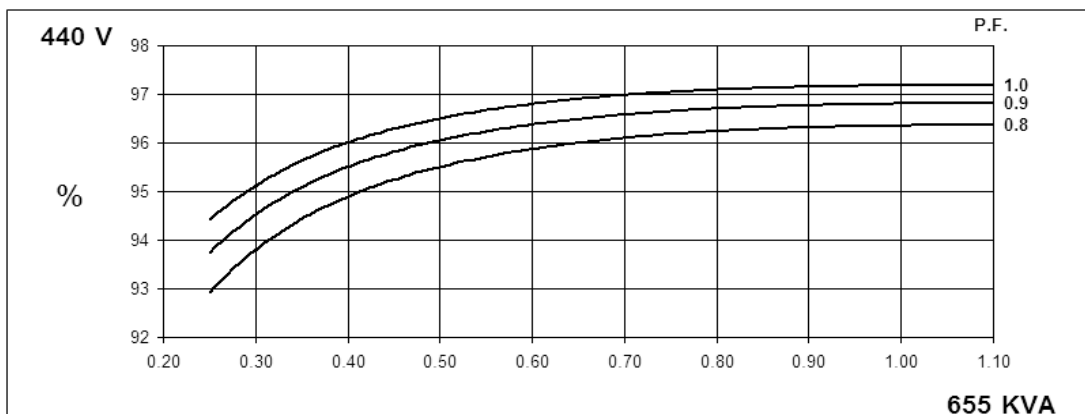
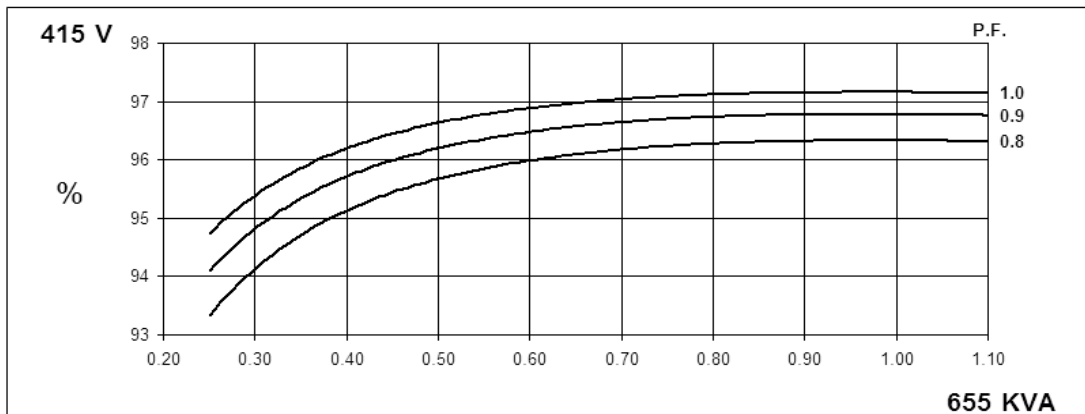
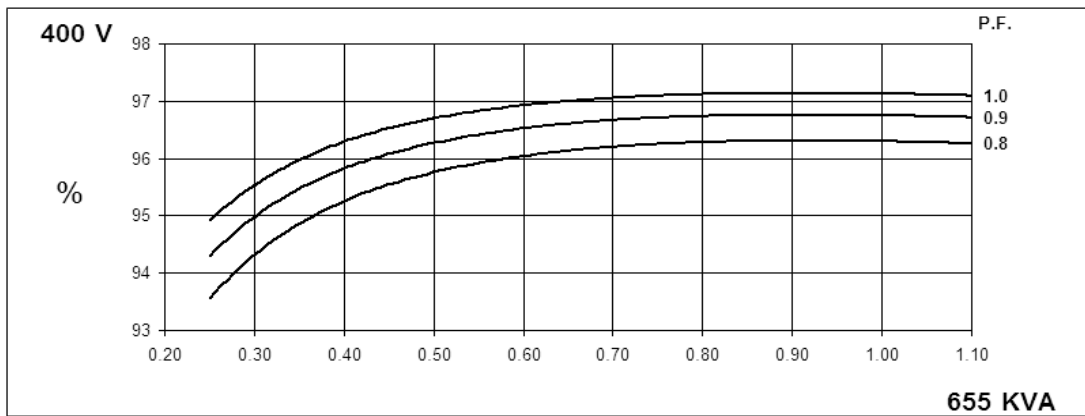
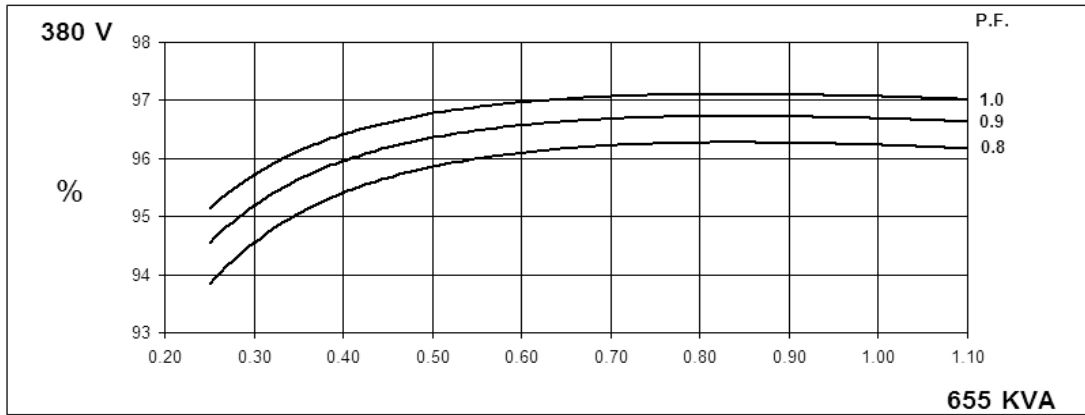

THREE PHASE EFFICIENCY CURVES

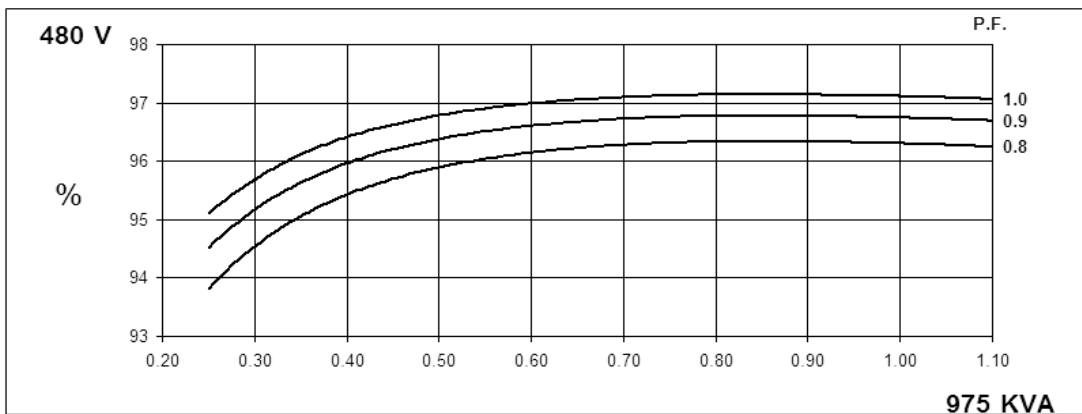
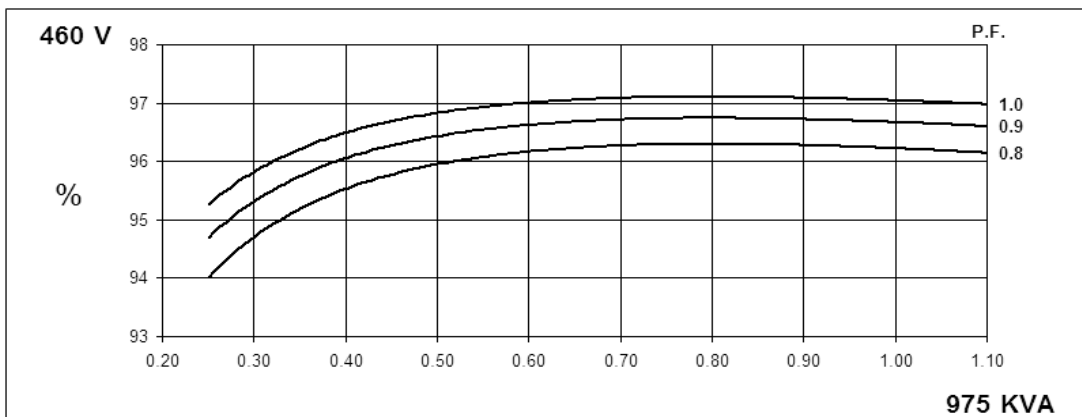
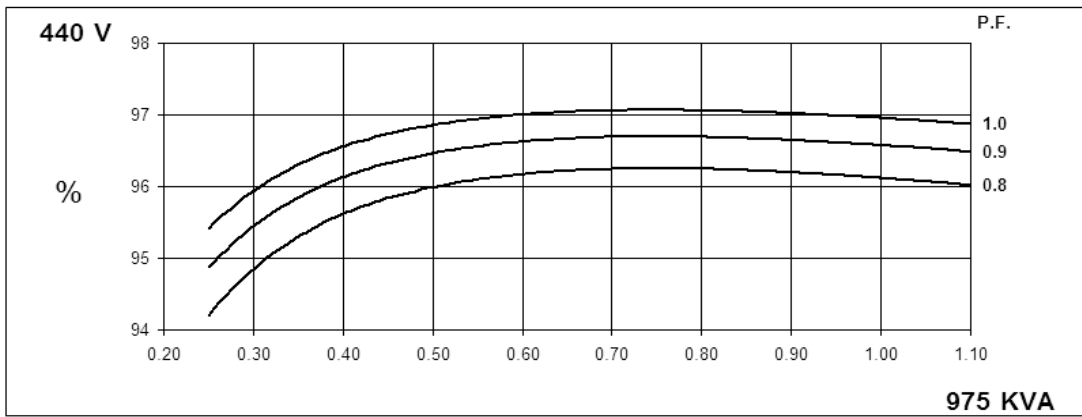
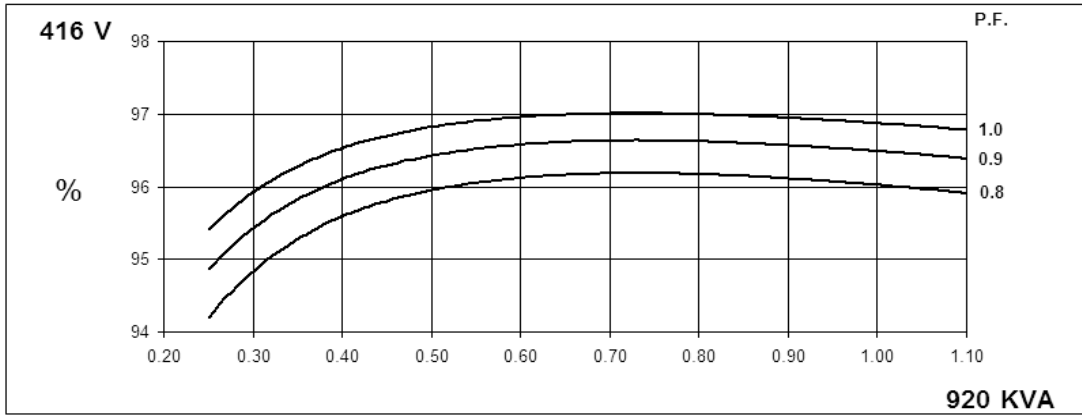

PM736D

Winding 312



Locked Rotor Motor Starting Curve

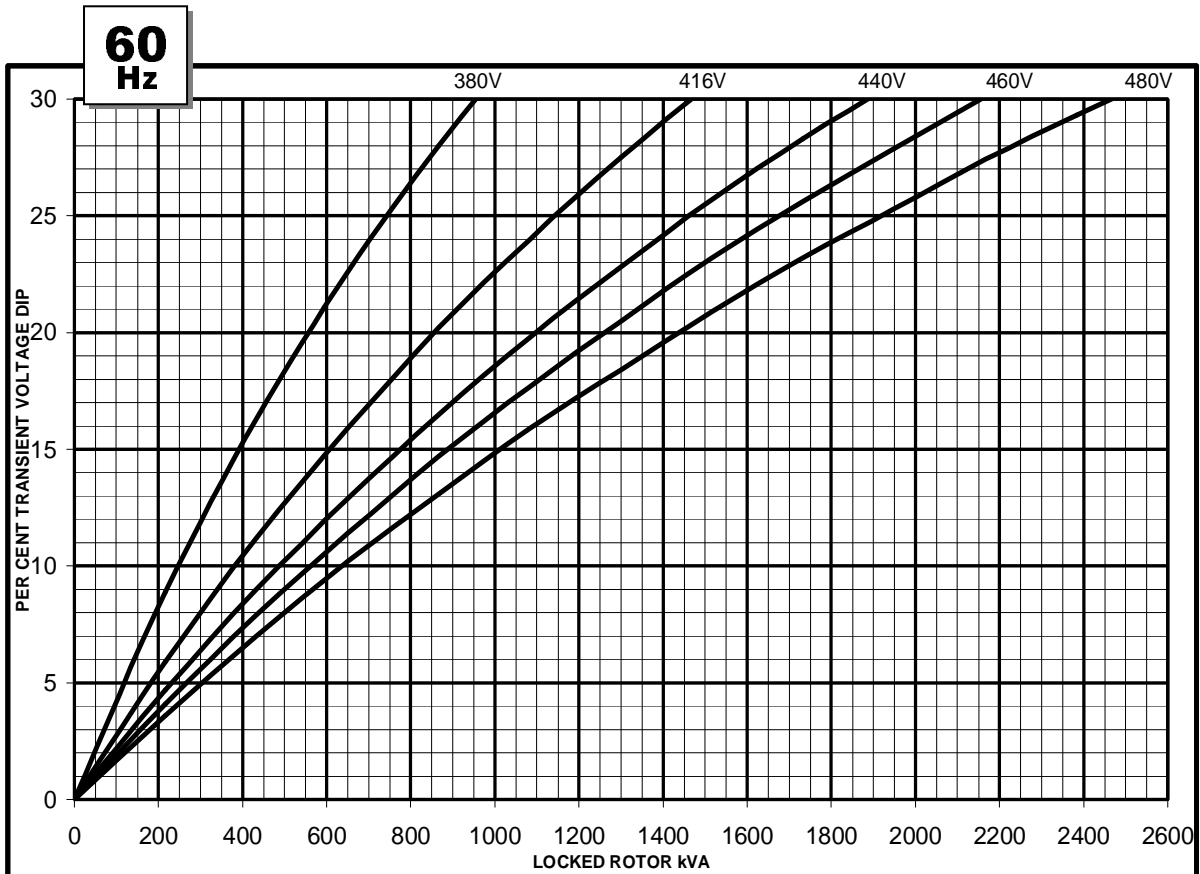
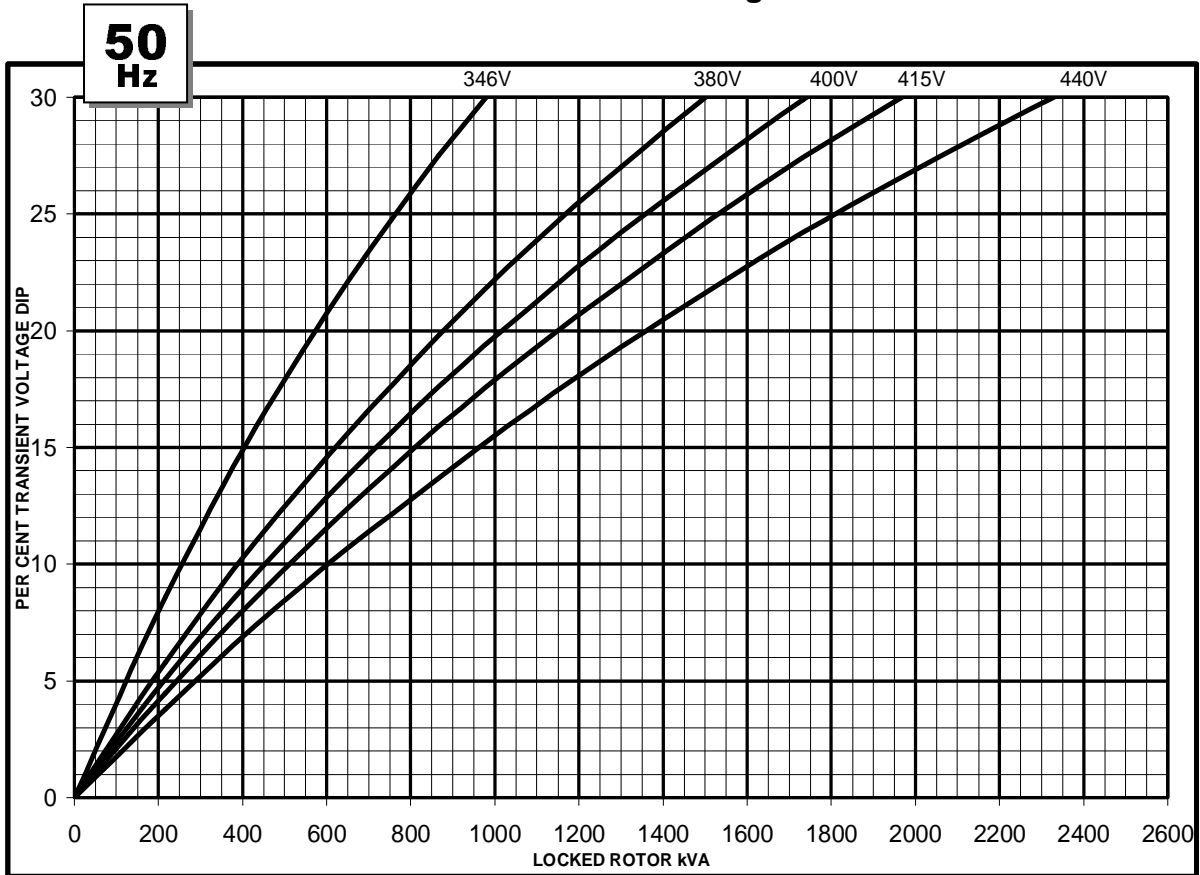

**Three-phase Short Circuit Decrement Curve. No-load Excitation at Rated Speed
Based on star (wye) connection.**

**50
Hz**

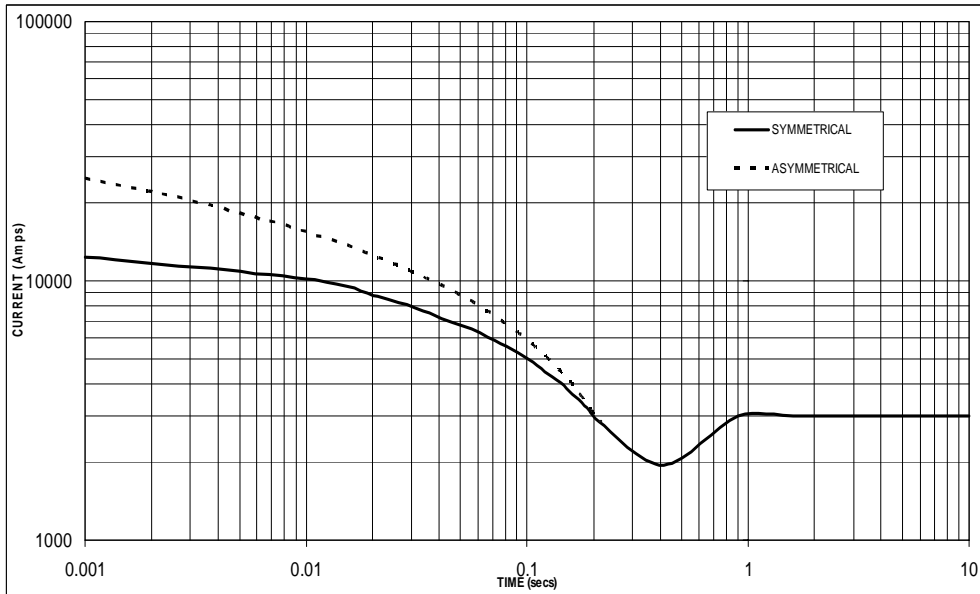

Sustained Short Circuit = 3,000 Amps

**60
Hz**

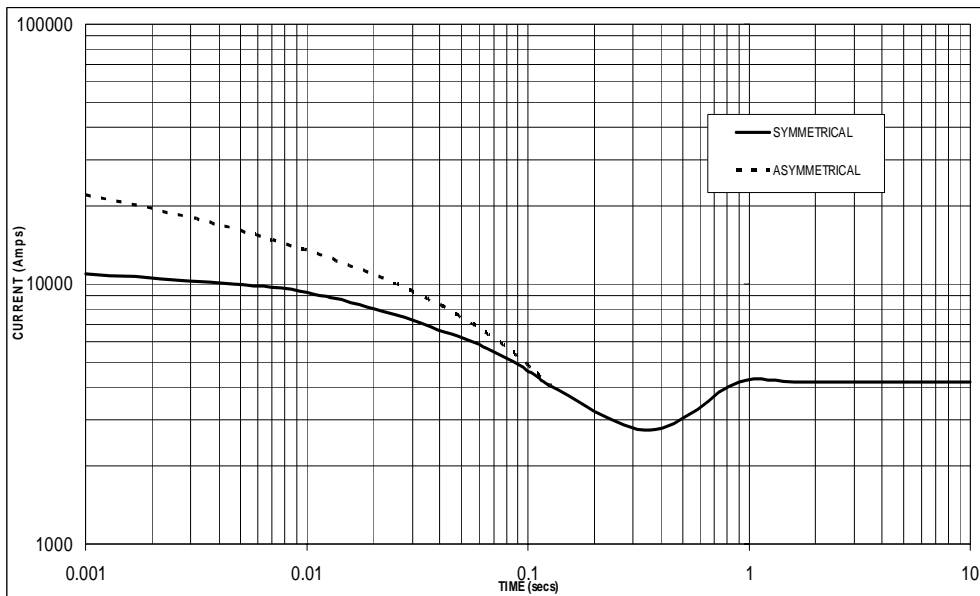

Sustained Short Circuit = 4,200 Amps

Note 1

The following multiplication factors should be used to adjust the values from curve between time 0.001 seconds and the minimum current point in respect of nominal operating

50Hz		60Hz	
Voltage	Factor	Voltage	Factor
380v	x 1.00	416v	x 1.00
400v	x 1.05	440v	x 1.06
415v	x 1.09	460v	x 1.10
440v	x 1.16	480v	x 1.15

The sustained current value is constant irrespective of voltage level

Note 2

The following multiplication factor should be used to convert the values calculated in accordance with NOTE 1 to those applicable to the various types of short circuit :

	3-phase	2-phase L-L	1-phase L-N
Instantaneous	x 1.00	x 0.87	x 1.30
Minimum	x 1.00	x 1.80	x 3.20
Sustained	x 1.00	x 1.50	x 2.50
Max. sustained duration	10 sec.	5 sec.	2 sec.

All other times are unchanged

Note 3

Curves are drawn for Star (Wye) connected machines.

PM736D

Winding 312 / 0.8 Power Factor



RATINGS

Class - Temp Rise		Cont. B - 70/50°C				Cont. F - 90/50°C				Cont. H - 110/50°C			
50Hz	Star (V)	380	400	415	440	380	400	415	440	380	400	415	440
	kVA	630	630	630	630	655	655	655	655	655	655	655	655
	kW	504	504	504	504	524	524	524	524	524	524	524	524
	Efficiency (%)	96.2	96.3	96.3	96.3	96.2	96.3	96.3	96.4	96.2	96.3	96.3	96.4
	kW Input	524	523	523	523	545	544	544	544	545	544	544	544

60Hz	Star (V)	416	440	460	480	416	440	460	480	416	440	460	480
	kVA	800	845	845	845	920	975	975	975	920	975	975	975
	kW	640	676	676	676	736	780	780	780	736	780	780	780
	Efficiency (%)	96.1	96.2	96.3	96.3	96.0	96.1	96.2	96.3	96.0	96.1	96.2	96.3
	kW Input	666	703	702	702	767	812	811	810	767	812	811	810

DIMENSIONS

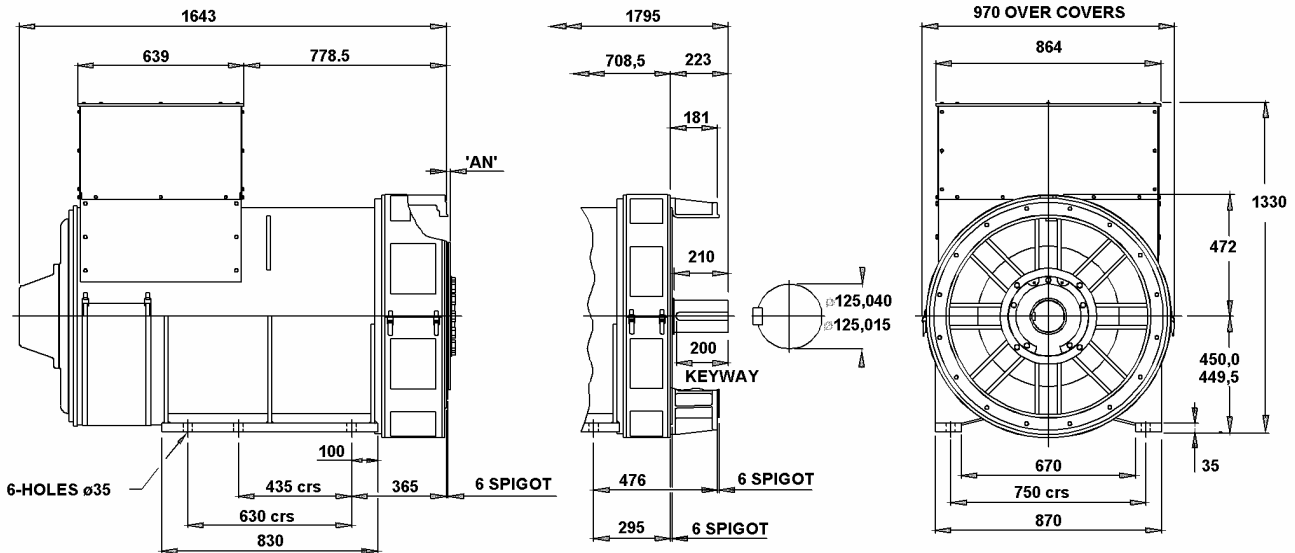

COUPLING DISC	'AN'
S.A.E No 18	15,7
S.A.E No 21	0
S.A.E No 24	0

1-BRG ADAPTORS
S.A.E No 0
S.A.E No 00

2-BRG ADAPTORS
S.A.E No 0
S.A.E No 00



Barnack Road • Stamford • Lincolnshire • PE9 2NB
 Tel: 00 44 (0)1780 484000 • Fax: 00 44 (0)1780 484100
 Website: www.newage-avkseg.com